

# SERIES MBD

Multi-Blade Linear  
Diffuser

PUBLICATION

DIFFUSERS 2

JULY 2015



## Features

- Singular or continuous designs.
- One or two way blow.
- Removable core with safety cord.
- Alternate frames available to match current ceiling designs.
- Extruded aluminium construction.
- Comprehensive series of matching plenum boxes.



**GILBERTS**

# SERIES MBD

Multi-Blade Linear Diffuser

## Introduction

Gilberts MBD Series complements existing rectangular and linear diffuser models to provide a continuous Louvre Face option. Combining up to date styling and design technology to blend with modern architecture the MBD maintains excellent air distribution characteristics providing smooth, even horizontal air discharge making the diffuser ideal for fan coil units as well as conventional ceiling diffuser applications.

Suitable for ceiling mounting the MBD is available in standard 100 to 400mm slot widths with both 1 and 2 way discharge patterns available as well as unequal splits on 2 way units. Manufactured throughout in extruded aluminium single units can be supplied up to 1.2m in one assembly with longer runs supplied in sections and joined, almost invisibly, with a simple alignment feature.

## Features

- Singular or continuous designs.
- One or two way blow.
- Removable core with safety cord.
- Alternate frames available to match current ceiling designs.
- Extruded aluminium construction.
- Comprehensive series of matching plenum boxes.

## Performance Data

The performance data gives information for cooling, ventilation and heating applications. The selection charts are based on a 1m length of diffuser complete with a standard plenum box, and mounted flush with a ceiling. The correction notes following and factor tables opposite should be used for other sizes and applications.

- **Pressure:** All pressures are in Pa (N/m<sup>2</sup>)
- **Throws:** All horizontal throws are for a distance measured in metres, and correspond to terminal velocities of 0.25m/s and 0.5m/s.

## Selection Procedure

- 1 Establish a position within the conditioned space to achieve the best air distribution.
- 2 Knowing the type of space, refer to (table 1) and establish the recommended maximum noise level for that type of area.
- 3 Divide the total area volume (m<sup>3</sup>/s) by the effective length of diffuser and establish a volume per metre run.
- 4 Establish the throw based on notes in the performance specification. One or two way direction.
- 5 Refer to selection charts and establish the width of units required to meet your requirements.

### EXAMPLE

A 4 metre length of diffuser is to be installed parallel with the external wall of a conditioned space. It is intended to distribute the air in one direction across the ceiling with a throw of 9 m to the opposite wall. The total volume of air supply has been calculated at 0.6m<sup>3</sup>/s. As the conditioned space is a office at NR level of 30 - 35 has been selected from table 1.

$$\text{Volume per metre required} = \frac{0.6}{4} = 0.15\text{m}^3/\text{s/m}$$

Now with a reference to the selection table for a MBD-1 200mm wide unit with this volume it would throw a distance of approximately 7m to a terminal velocity of 0.25m/s. As the diffuser is over 3 metres in length then the correction of 1.4 must be used which would give a final throw of 7 x 1.4 = 9.8 metres. As this is close to the required throw and at a lower terminal velocity it can be accepted as if the correction for cooling is applied this would reduce this figure to 9.8 x 0.9 = 8.82m.

Noise levels have been given as NR30 which is within the required level selected.

Three standard border details are available to match most popular ceiling designs with end flanges optionally available. In addition, the MBD is complemented by a comprehensive range of purpose built plenum boxes. Manufactured from galvanised or zintec coated Mild Steel the boxes can be supplied to suit all diffusers in sectional box lengths up to 1200mm. Connection between the boxes and diffusers is accomplished via concealed bracket fixings accessible through the diffuser face. For installations without plenums, support brackets for drop rod fixings are provided. For volume control standard screwdriver operated opposed blade dampers can be fitted to the back of the diffuser.

Alternatively the plenum inlet can be fitted with Quadrant or Iris type dampers and, where adjustment via the face is preferred, both cord and teleflex operated spigot dampers can be installed.



- **Sound:** The NC values are based on limited room absorption and for one length of diffuser with damper fully open. Please note that noise level data is only available down to NR20.

### (HORIZONTAL PROJECTION)

If the diffuser is mounted on exposed ductwork the throws given will be reduced by approximately 40%.

### PLENUM BOXES

Standard Plenum box details are shown on page 7 and are the recommended minimum to obtain even distribution along the diffuser using a centre fed constant cross section plenum box. If side entry cannot be accommodated, and only top entry proves possible, then all boxes must be complete with a perforated baffle section.

TABLE 1

Area to be Served	Recommended Maximum NR Levels
Sound Broadcasting Studios	15 - 20
Recording Studios TV (Audience Studios)	20 - 25
Lecture Theatres, Cinemas, Concert Halls, Boardroom/Ex Offices Lounge, Conference Room, Court Room, Churches, Private Bedrooms	25 - 30
Operating Theatres, Hospital Wards, Staff Room, Class Rooms, Ballroom, Banquet Room, Library, Bank, Museum, Offices	30 - 35
Restaurant, Department Stores Computer Suite, Washroom Toilet	35 - 40
Laundries, Kitchens, Swimming Pools, Sports Arena	40 - 45
Garage, Light Engineering Workshop	45 - 50
Heavy Engineering Workshops	50 - 65

# Type MBD/1 One Way Discharge

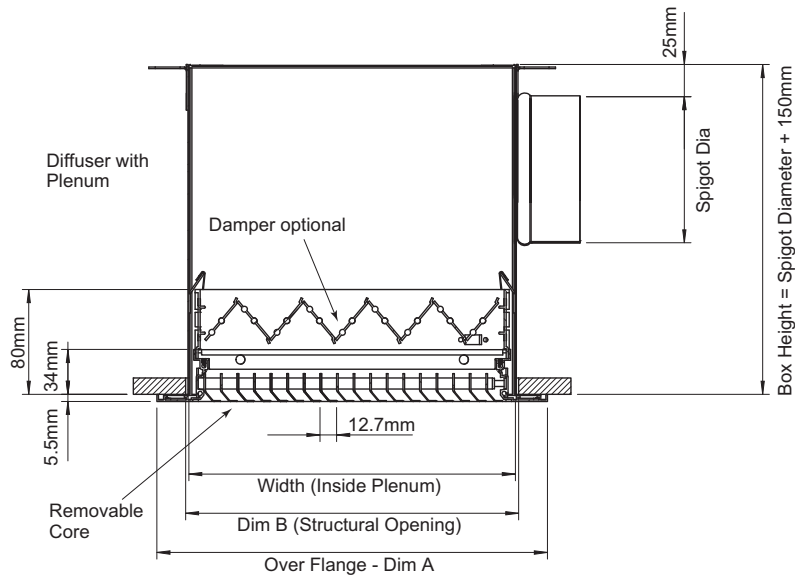

DIMENSIONAL DATA			
WIDTH	DIM 'A'	DIM 'B'	TOTAL BLADES
100	149	105	6
150	199	155	10
200	249	205	14
250	299	255	18
*250 TEG	294	255	18
245	294	250	18
300	349	305	22
350	399	355	26
400	449	405	30

\*250 Teg - Designed to suit 15mm T Bar  
Visible Face Width = 284mm  
Overflange Width = 294mm

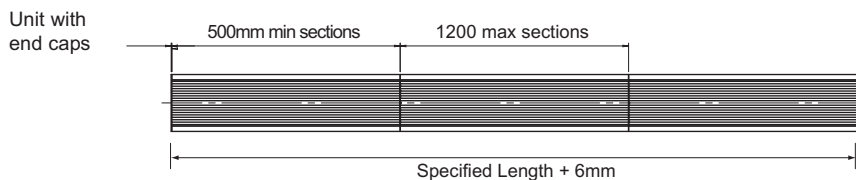
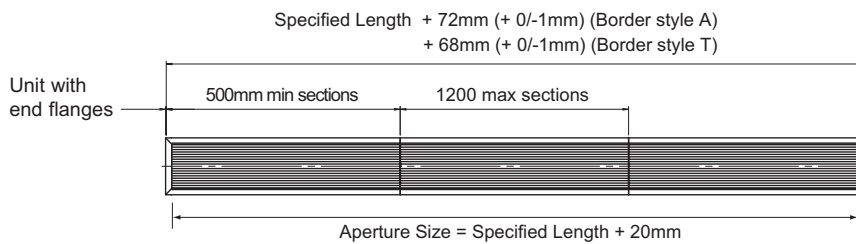
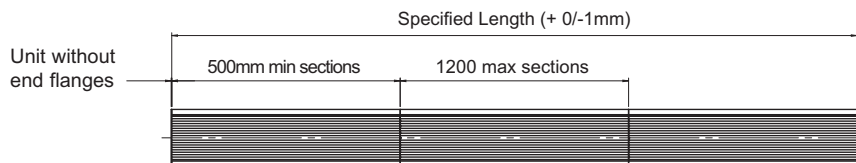



# Type MBD/2 two Way Discharge

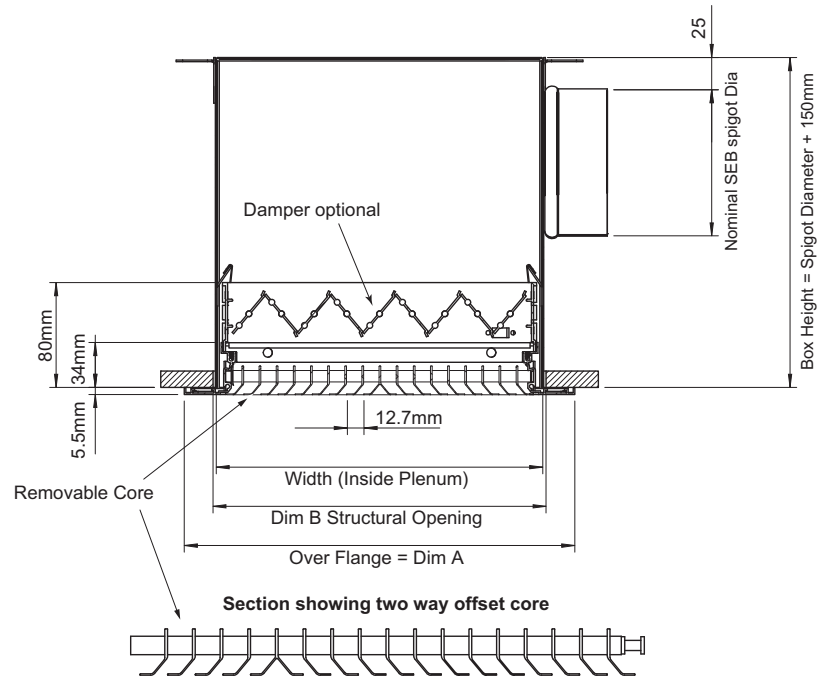

DIMENSIONAL DATA										
WIDTH	DIM 'A'	DIM 'B'	TOTAL BLADES	CORE CONFIGURATIONS						
100	149	105	6	3-3						
150	199	155	10	5-5	3-7					
200	249	205	14	7-7	3-11	5-9				
250	299	255	18	9-9	3-15	5-13	7-11			
*250 TEG	294	255	18	9-9	3-15	5-13	7-11			
245	294	250	18	9-9	3-15	5-13	7-11			
300	349	305	22	11-11	3-19	5-17	7-15	9-13		
350	399	355	26	13-13	3-23	5-21	7-19	9-17	11-15	
400	449	405	30	15-15	3-27	5-25	7-23	9-21	11-19	13-17

\*250 Teg - Designed to suit 15mm T Bar  
Visible Face Width = 284mm  
Overflange Width = 294mm

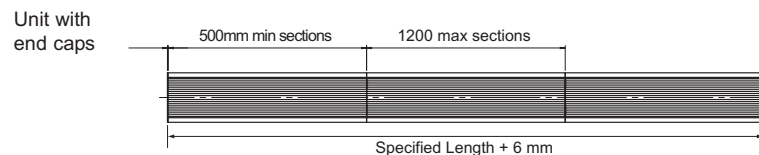
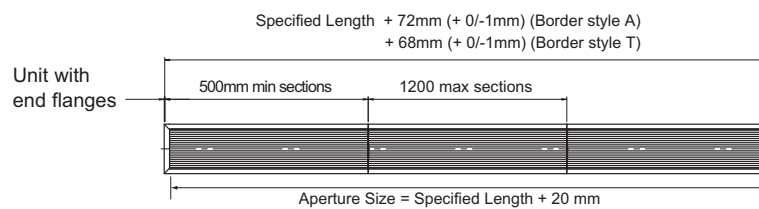
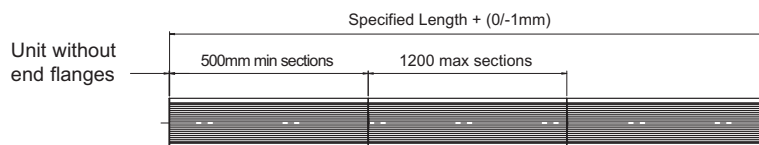

# SERIES MBD

Multi-Blade Linear Diffuser

## Border Options

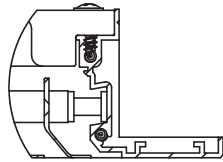

Standard ..... Type A

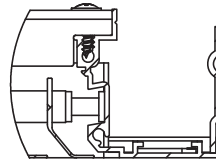

Plank Ceiling ..... Type B

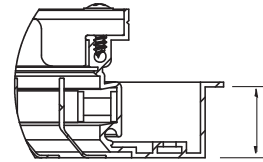

Tegular Ceiling ..... Type T

Factory Set From  
6-19mm  
Please Specify

## Fixing Arrangements

### Drop Rod Fixing

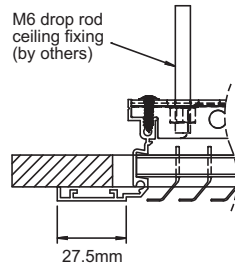

### Screw Flanged Fixing ..... FF

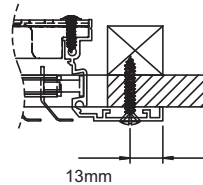

### Concealed Leg Bracket Fixing

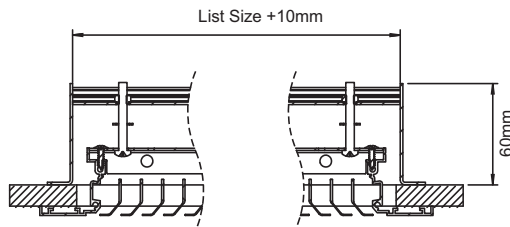

For independant support of slot diffuser

Ref .... LB

### Concealed Bracket Fixing

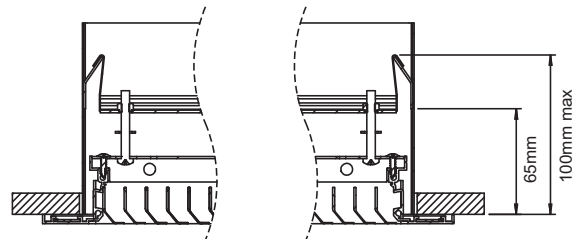

For use in installations where plenum boxes are installed

Ref .... CB

## Alignment Feature

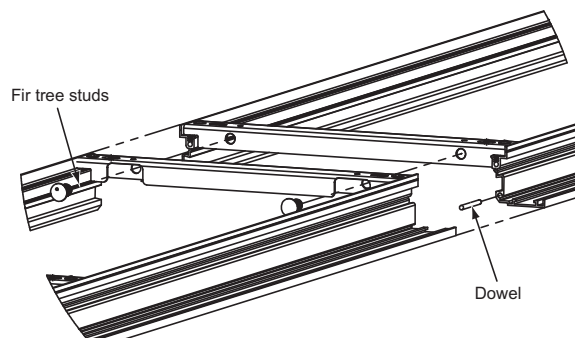

For long continuous runs a concealed alignment feature is provided for positive and accurate joining of diffuser lengths.



## End Flanges And End Caps

**Standard Border  
Mitred Ends**

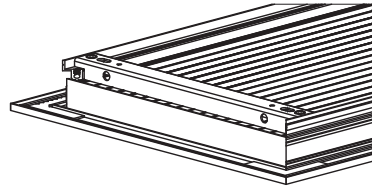

**Tegular Border  
Mitred Ends**

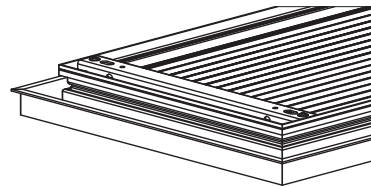

**Standard Border  
End Caps**

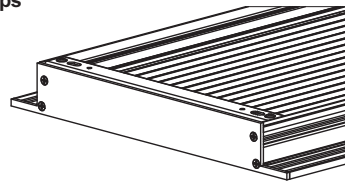

## Blanking Plates

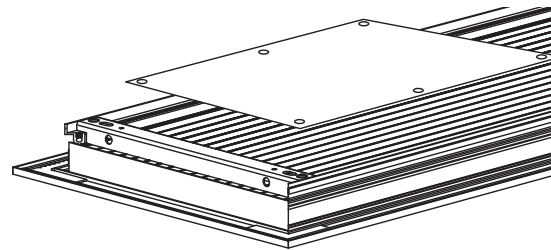

For inactive dummy sections, matt black blanking plates can be supplied. Blanking plates simply locate into the back of the diffuser where they can be secured with standard self-tapping screws.

## Mitred Corners

Conventional 90° angle mitred corners available supplied pre-assembled in 200 x 200 section with fixed (not removeable) core.

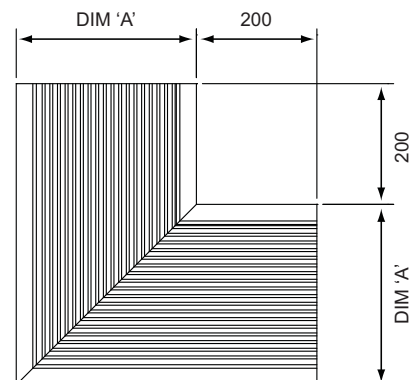

# SERIES MBD

Multi-Blade Linear Diffuser

## Plenum Box Series PB

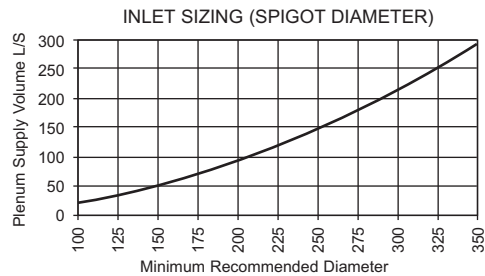
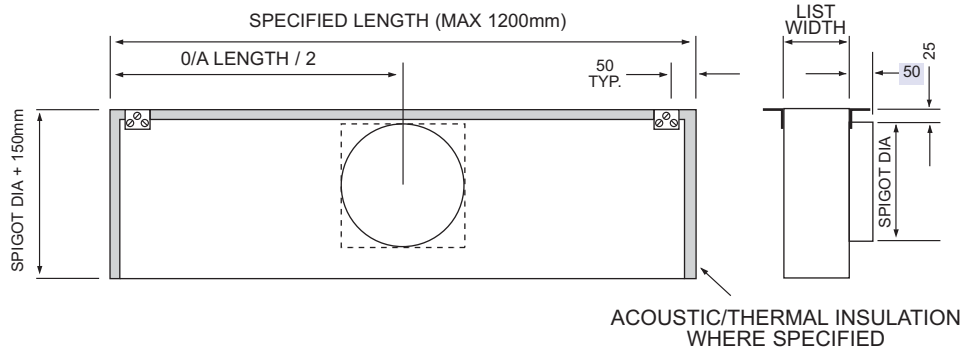

For low noise levels one size larger is recommended

Due to the demanding airflow characteristics of this type of diffuser the plenum internal arrangement will be configured by Gilberts to match each diffuser. Performance problems can occur where Gilberts' plenums are not installed.

### General Specification

- 0.7mm Galvanised or Zintec coated mild steel construction.
- Spigot Construction: Standard sizes use plastic clip-in spigot. Non-standard, a sealed screw-in spigot.
- Plenums include open ends (for continuous runs) closed ends need to be specified.
- Thermal Insulation: 12mm Pyrosorb foam approx. U-value 4.7 Wm<sup>-2</sup> k-1
- Plenum dimensional data provides useful information for installation purposes only and is not suitable for manufacturing detail.

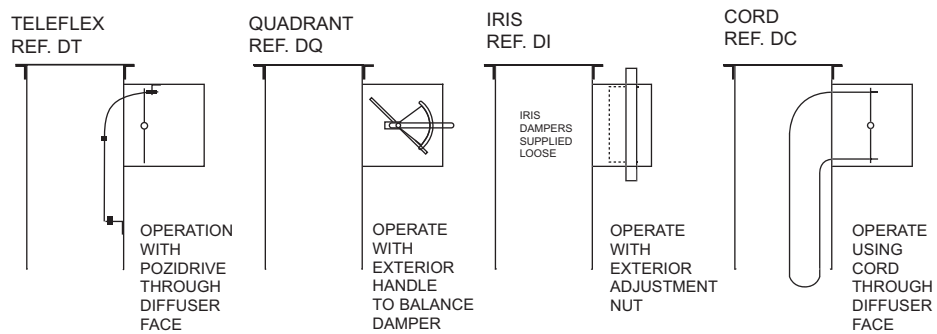

Spigot length = Spigot dia.



## Performance Chart One way

TYPE MBD/1							
Width	Terminal Velocity	Pressure	2 Pa	4 Pa	7Pa	9Pa	15Pa
		Neck Velocity	0.5	0.75	1	1.25	1.5
100	0.5/0.25m/s	Volume m <sup>3</sup> /s/m	0.035	0.05	0.07	0.08	0.10
		Throw m	1.2/2.7	2.1/3.8	3.0/5.0	5.0/7.2	7.0/9.5
		Noise NR	24	27	30	32	34
		Volume m <sup>3</sup> /s/m	0.06	0.09	0.12	0.15	0.18
150	0.5/0.25m/s	Throw m	2.0/3.5	3.2/5.0	4.5/6.5	6.0/8.5	7.8/10.5
		Noise NR	24	26	30	32	35
		Volume m <sup>3</sup> /s/m	0.085	0.12	0.17	0.21	0.25
		Throw m	2.8/3.9	4.3/5.9	5.8/8.0	7.0/9.7	8.4/11.5
200	0.5/0.25m/s	Noise NR	25	28	31	33	35
		Volume m <sup>3</sup> /s/m	0.11	0.16	0.22	0.27	0.33
		Throw m	2.9/4.0	4.6/6.4	6.5/8.5	8.0/11.0	9.7/13.0
		Noise NR	25	27	30	34	38
250	0.5/0.25m/s	Volume m <sup>3</sup> /s/m	0.13	0.20	0.27	0.34	0.40
		Throw m	3.0/4.2	5.0/7.0	7.0/9.0	9.0/13.0	11.0/15.0
		Noise NR	26	28	29	32	40
		Volume m <sup>3</sup> /s/m	0.16	0.24	0.32	0.40	0.48
300	0.5/0.25m/s	Throw m	3.6/5.0	5.6/8.0	7.7/11.0	10.0/14.0	12.0/16.0
		Noise NR	27	29	30	34	41
		Volume m <sup>3</sup> /s/m	0.18	0.27	0.37	0.46	0.55
		Throw m	4.2/5.8	6.3/9.0	8.5/12.0	11.0/15.0	13.0/17.0
350	0.5/0.25m/s	Noise NR	29	30	31	35	43

## Performance Chart Two way

TYPE MBD/2							
Width	Terminal Velocity	Pressure	2 Pa	4 Pa	7Pa	9Pa	15Pa
		Neck Velocity	0.5	0.75	1.0	1.25	1.5
100	0.5/0.25m/s	Volume m <sup>3</sup> /s/m	0.03	0.05	0.07	0.08	0.10
		Throw m	0.8/1.2	1.3/1.8	1.8/2.5	2.3/3.1	2.9/3.8
		Noise NR	24	27	30	32	34
		Volume m <sup>3</sup> /s/m	0.06	0.09	0.12	0.15	0.18
150	0.5/0.25m/s	Throw m	1.1/1.6	1.7/2.2	2.2/3.2	2.9/4.0	3.7/5.0
		Noise NR	24	26	30	32	35
		Volume m <sup>3</sup> /s/m	0.08	0.12	0.17	0.21	0.25
		Throw m	1.4/2.0	2.0/3.0	2.7/4.0	3.6/5.0	4.5/6.0
200	0.5/0.25m/s	Noise NR	25	28	31	33	35
		Volume m <sup>3</sup> /s/m	0.11	0.16	0.22	0.27	0.33
		Throw m	1.6/2.2	2.3/3.3	3.1/4.4	3.9/5.5	4.9/6.8
		Noise NR	25	27	30	34	38
250	0.5/0.25m/s	Volume m <sup>3</sup> /s/m	0.135	0.204	0.27	0.34	0.40
		Throw m	1.8/2.5	2.6/3.6	3.5/4.8	4.3/6.1	5.3/7.4
		Noise NR	26	28	29	32	40
		Volume m <sup>3</sup> /s/m	0.16	0.24	0.32	0.40	0.48
300	0.5/0.25m/s	Throw m	1.9/2.7	2.8/4.0	3.7/5.4	4.9/6.8	6.1/8.2
		Noise NR	27	29	30	34	41
		Volume m <sup>3</sup> /s/m	0.18	0.27	0.37	0.46	0.55
		Throw m	2.1/3.0	3.0/4.5	4.0/6.0	5.5/7.5	7.0/9.0
350	0.5/0.25m/s	Noise NR	29	30	31	35	43

The above tables are based on tests conducted on a 1000mm length of diffuser. Correction factors should be applied to acoustic and throw data for continuous lengths. Noise data is expressed in NR figures with a minimum room absorption factor of 8dB. Throws are based on a terminal velocity of 0.5m/s and 0.25m/s isothermal conditions.

### Correction factors for other supply temperatures

Cooling 10° Δt throws x 0.9
Heating 10° Δt throws x 1.15

### Correction Factors for Length

Length	0.9	1.0	1.2	1.5	2.0	3+
Multiple throw by	0.9	1.0	1.1	1.2	1.3	1.4
Add to NR level	-1	0	+1	+2	+3	+4

All data is based on 1 metre long diffuser, isothermal conditions, damper full open and diffuser flush with ceiling. Based on a room height of 2.8 metres.

**Extract :** If units are used for extract purposes then the following correction factors

should be used: • Pressure figures for supply x2 • Noise figures as for supply

Gilberts Supply Diffusers have been tested within the range of +/- 10°C (as recommended in the HEVAC Guide to Air Distribution Technology). For any other temperature differential requirements please contact our Technical Department.





## Ordering Specification Diffusers

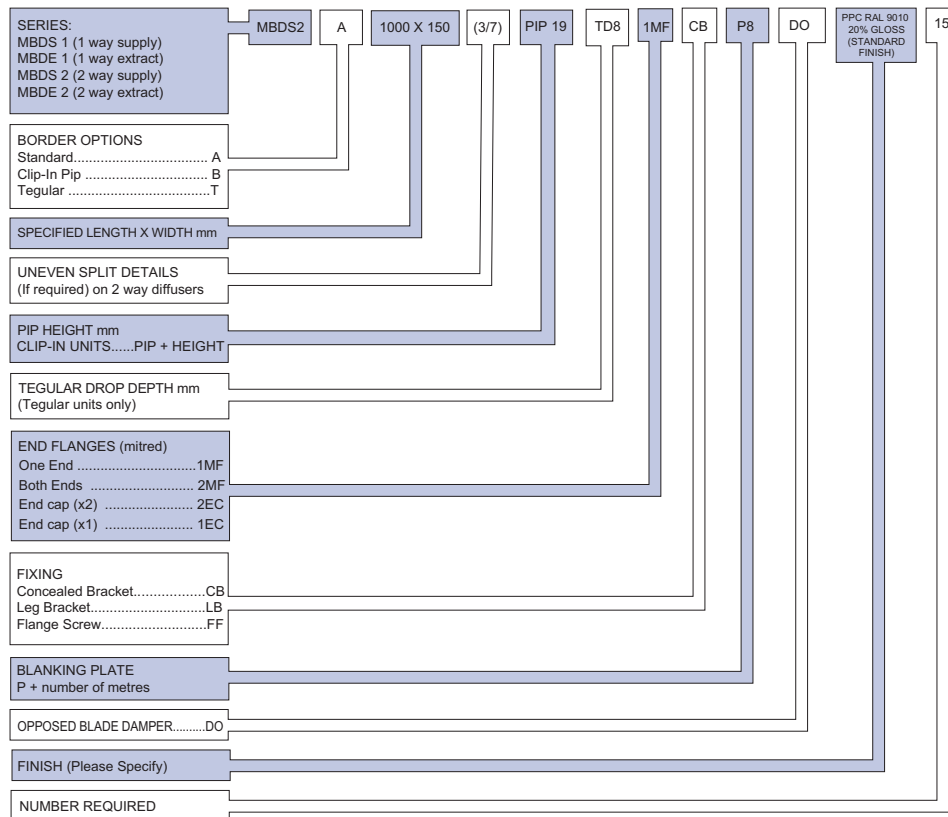

### FIXING

Support brackets for drop rods are built in as standard. Fixings can be mixed and matched on long runs to suit the installation. Optional fixings as below.

- Support Brackets ..... Built in. Used for units or lengths where no plenum box is fitted.
- Concealed Brackets.....(CB) Standard for plenum box fixing.
- Leg Bracket.....(LB) Alternative to standard CB typically for plasterboard fixing.
- Flange fixed.....(FF) Screw through flange.

### BLANKING PLATES

Screw fix matt black blanking plates available for dummy/inactive sections and are fitted to the back of the diffuser. Supplied in 150mm lengths.

### FINISH

- Standard finish: Polyester powder coat white RAL 9010 20% gloss
- Special Finishes: Polyester powder finish to stock BS/RAL colour.

# SERIES MBD

Multi-Blade Linear Diffuser

## Ordering Specification Plenums

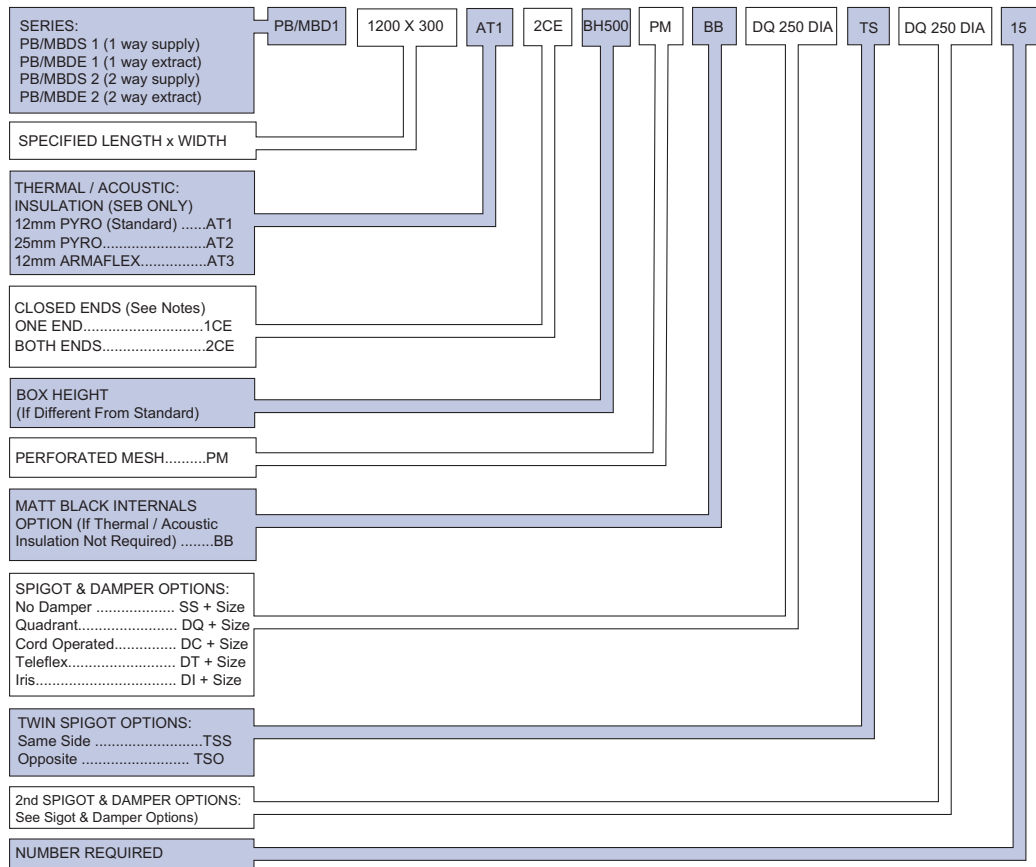

### THERMAL/ACOUSTIC INSULATION

Plenum can be fully lined with 12mm (standard) or 25mm Pyrosorb thermal/acoustic insulation as well as 12mm Armaflex.

### CLOSED ENDS

All plenums include cut outs at each end of the Box to allow units to be placed over diffusers in continuous runs. To reduce leakage on single units or at the ends of long runs, please specify closed ends where required. Closed ends are push fit and so can be removed, or swapped to suit handing where necessary.

### PERFORATED MESH

Plenum fitted internally with 50% perforated Equalising mesh.

### SPIGOT OPTIONS

Plenums can be supplied with either single or twin inlets and mounted on the same, or opposite sides of the box. Each spigot can also be fitted with quadrant, cord, teleflex or iris dampers.

### PLENUM DESIGN

Due to the demanding airflow characteristics of this type of diffuser the plenum internal arrangement will be configured by Gilberts to match each diffuser. Performance problems can occur where Gilberts plenums are not installed.

Plenums are normally required for all diffusers and are only unnecessary for bulkhead applications.

## GILBERTS

Head Office and Works  
**GILBERTS (BLACKPOOL) LTD**  
 Gilair Works, Clifton Road,  
 Blackpool.  
 Lancashire FY4 4QT.  
 Telephone: (01253) 766911  
 Fax: (01253) 767941  
 e-mail: sales@gilbertsblackpool.com  
 Web: www.gilbertsblackpool.com

